

PVC Tunnel Type Drainage Pipe

- Highway tunnel, bridge infrastructures
- Dam and watering infrastructures
- Building, Mall, TOKİ and facility infrastructures
- Retaining wall

SPECIFICATIONS

- Horseshoe cross sectioned
- Base is flat for easy water flow
- Standard muff on one side
- Horizontal water inlet holes between the gutters
- Water inlet area $\geq 5500 \text{ mm}^2/\text{m}$
- Resistance to UV
- Blue colored
- 6 m. length

UNIT SPECIFICATIONS

DN 100

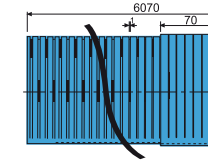

DN (nominal diameter)	: 100 mm
Outer diameter \emptyset	: 110 mm
Inner diameter \emptyset	: < 99 mm
Outer height	: 110 mm
Weight	: 0,700 kg/m
Cross section area	: 100 cm ²
Water inlet area	: $\geq 5016 \text{ mm}^2/\text{m}$
Pipe length	with muff : 6070 mm without muff : 6000 mm

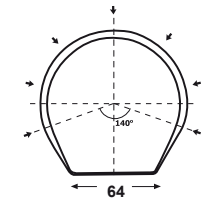

DN 150

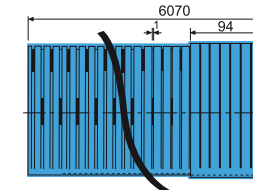

DN (nominal diameter)	: 150 mm
Outer diameter \emptyset	: 160 mm
Inner diameter \emptyset	: 147 mm
Outer height	: 160 mm
Weight	: 1,180 kg/m
Cross section area	: 210 cm ²
Water inlet area	: $\geq 5500 \text{ mm}^2/\text{m}$
Pipe length	with muff : 6070 mm without muff : 5970 mm

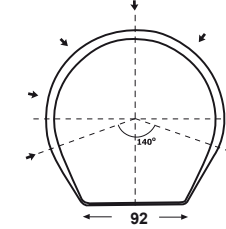

DN 200

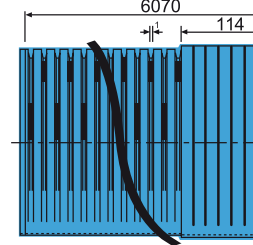

DN (nominal diameter)	: 200 mm
Outer diameter \emptyset	: 215 mm
Inner diameter \emptyset	: 193 mm
Outer height	: 215 mm
Weight	: 1,70 kg/m
Cross section area	: 375 cm ²
Water inlet area	: $\geq 5500 \text{ mm}^2/\text{m}$
Pipe length	with muff : 6070 mm without muff : 5970 mm

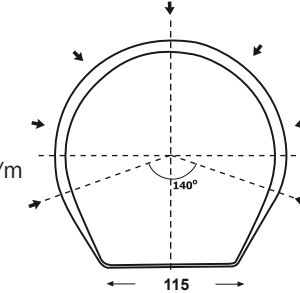

DN 315

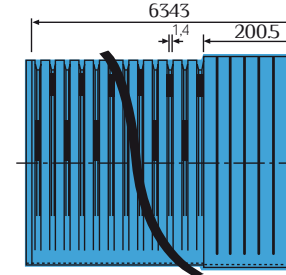

DN (nominal diameter)	: 325 mm
Outer diameter \emptyset	: 325 mm
Inner diameter \emptyset	: 294 mm
Water inlet area	: $\geq 5500 \text{ mm}^2/\text{m}$
Outer height	: 325 mm
Weight	: 3,6 kg/m
Cross section area	: 847 cm ²
Pipe length	with muff : 6343 mm without muff : 6144 mm

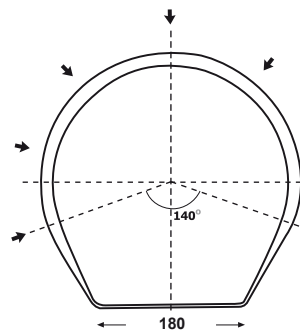

DN 355

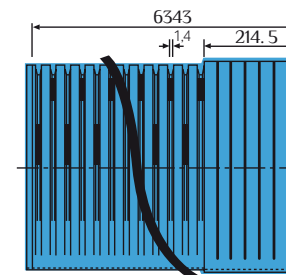

DN (nominal diameter)	: 355 mm
Outer diameter \emptyset	: 350 mm
Inner diameter \emptyset	: 316 mm
Water inlet area	: $\geq 5500 \text{ mm}^2/\text{m}$
Outer height	: 350 mm
Weight	: 4,1 kg/m
Cross section area	: 982 cm ²
Pipe length	with muff : 6343 mm without muff : 6130 mm

